

**DRAIN KING & PLUNGERS**

ITEM NO.	MFG.	DESCRIPTION	CTN. QTY.
----------	------	-------------	-----------

**DRAIN KING® DRAIN UNCLOGGERS**

12-1008	340	Complete kit • Drain King • 10ft. Hose • Faucet Adapter	12
12-1010	186	For 1-1/2" to 3" Drains	12
12-1012	501	For 1" to 2" Drains	12
12-1014	750	For 3" to 6" Drains	12
12-1016	H34	For 3" to 4" Drains	12
12-1018	VIP1	Kit For 1" to 2" Drains • Includes #501 Drain King plus Drain Adapter and Faucet Adapter	12
12-1000	DK-Mini	Mini Drain Snake	36
12-1024	B113C	22" Flexible Drain Brush	12

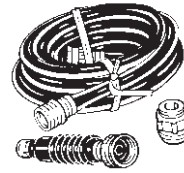

12-1008



12-1010



12-1012



12-1014



12-1016



12-1018



12-1000

**TOILET PLUNGERS**

02-5000		<b>MAGNAFLEX</b> Plunger • Yellow Handle	4
02-5000-24		<b>MAGNAFLEX</b> Plunger • Yellow Handle	24
02-5004		Bee Hive Plunger	12
<b>02-5020</b>		<b>Clear Handle • 5-3/4" Red Cup</b>	<b>12</b>
02-5030	C-11	Economy Red Plunger • 20" Handle 4" Cup	12
02-5032	C-12	Economy Red Plunger • 20" Handle 5-1/2" Cup	12
02-5034	C-15	Economy Red Plunger • 9" Handle 4" Cup	12
02-5040	C-19	Hydro Blast Plunger	12
02-5046	MP100	Blue Master Plunger	12
02-5048	MP500	Plunger with Air Release	12

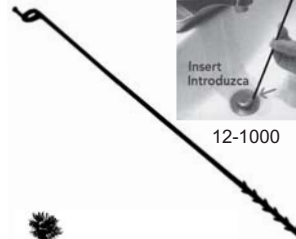

12-1024



02-5000  
02-5004



12-1024

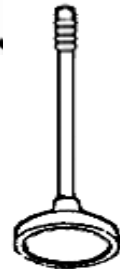

02-5020

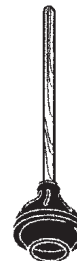

02-5040



02-5046  
02-5048

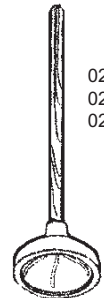

02-5030  
02-5032  
02-5034

**SAFE-T-SEAL TEST PLUGS**

12-1020	TP122	Pneumatic/Hydraulic Test plug For 1-1/4" to 2" Lines	1
12-1022	TP34SB	Pneumatic/Hydraulic Test plug For 3" and 4" Lines	1



12-1020



12-1022

**PNEUMATIC EXTENSION HOSE**

12-1030	CH4	4ft. Extension hose	1
---------	-----	---------------------	---



12-1030



**STEEL HAND SNAKES**

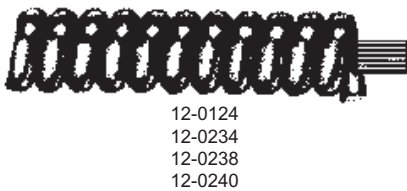
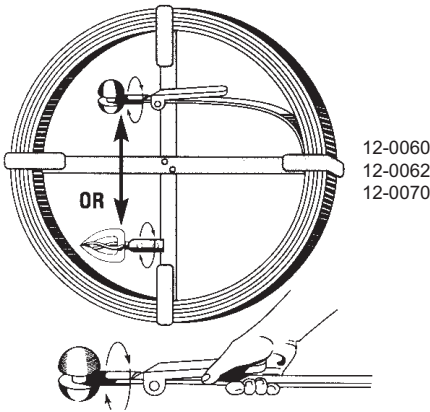
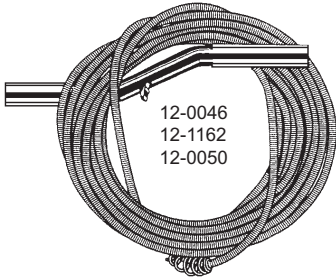
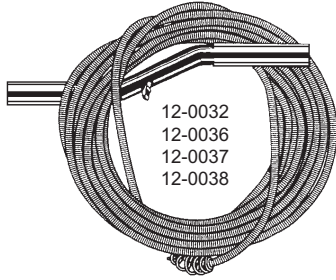
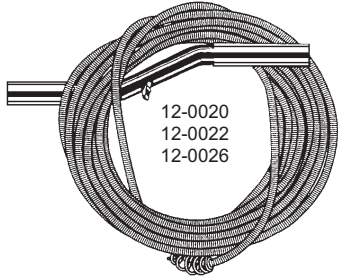

ITEM NO.	MFG.	DESCRIPTION	CTN. QTY.
----------	------	-------------	-----------

**BRIGHT WIRE HAND SNAKE**

Bright steel spring wire-type • Metal Handle • Snake and tip one continuous piece.

12-0020	8PQZ	1/4" x 8ft. Economy hand snake	1
12-0022	15PQZ	1/4" x 15ft. Economy hand snake	1
12-0026	25PQZ	1/4" x 25ft. Economy hand snake	1
12-0032	15PMZ	3/8" x 15ft. Economy hand snake	1
12-0036	25PMZ	3/8" x 25ft. Economy hand snake	1
12-0037	35PMZ	3/8" x 35ft. Economy hand snake	1
12-0038	50PMZ	3/8" x 50ft. Economy hand snake	1
12-0046	25PLZ	1/2" x 25ft. Economy hand snake	1
12-1162	T-1138	1/2" x 35ft. Economy hand snake	1
12-0050	50PLZ	1/2" x 50ft. Economy hand snake	1

**FLAT SEWER SNAKES**

Oil tempered spring steel is resistant to rusting and kinking. The rod is bolted to the frame at the back, so it can't spring out of the frame when you near the end.

A comfortable, efficient Quick-Grip Handle makes the work go faster. 1/4" x 1/16" size has spring head and steel bushed wood grip handle.

All other sizes furnished with Quick-Grip Handle and Roller Head, unless another head is specified.

12-0060	25B	Flat 1/2 x 1/16 x 25ft. snake	1
12-0062	50B	Flat 1/2 x 1/16 x 50ft. snake	1
12-0070	50H	Flat 1/2 x 1/8 x 50ft. snake	1

**FLEXICORE WIRE ROPE CENTER CABLES**

Heavy-gauge wire coiled tightly around 42-strand aircraft-type wire rope and heat-treated.

Has unequalled strength and the right amount of flexibility.

So tough it carries a one-year warranty against defect or breakage.

12-0124	25HE-1	1/4" x 25ft. Flexicore refill	1
12-0150	50HE-1	1/4" x 50ft. Flexicore refill	1
12-0200	50HE-1A	5/8" x 50ft. Flexicore refill	1
12-0234	35HE-2	3/8" x 35ft. Flexicore refill • Female end	1
12-0238	50EM-2	3/8" x 50ft. Flexicore refill • Male/Female end	1
12-0240	75EM-2	3/8" x 75ft. Flexicore refill • Male/Female end	1
12-0260	L50FL3-DH	1/2" x 50ft. Flexicore refill with down head	1



**ACCESSORIES**

ITEM NO.	MFG.	DESCRIPTION	CTN. QTY.
12-0400	1-1/2UC	1-1/2" U Cutter • For cutting and scraping For 3/8" and 1/2" Cable	1
12-0402	BG	Boring Gimlet • For removing loose objects For 5/16" and 3/8" Cable	1
12-0404	2UC	2" U Cutter • For cutting and scraping For 1/2", 5/8" and 3/4" Cable	1
12-0406	3RSB	3" Rotary Saw Blades (2Piece Set) For cutting and scraping For 1/2", 5/8" and 3/4" Cable	1
12-0420	FAH	Flexible Arrow Head • For sharp turns in small lines For 3/8" and 1/2" Cable	1
12-0422	AH	Arrow Head Starting Drill For 5/16", 3/8" and 1/2" Cable	1
12-0428	1-1/4SCB	Cutter Blades (2Piece Set) For cutting and scraping For 5/16" and 3/8" Cable	1
12-0430	SCB	2" Cutter Blades (2Piece Set) For cutting and scraping For 1/2", 5/8" and 3/4" Cable	1
12-0432	SCB	Same as above but 3"	1
12-0434	SCB	Same as above but 4"	1
12-0450	SV-25	Cable Gripper	1
12-0452	DHF	Down Head Fitting • Can be used with all standard Handyelectric cutters For 5/16" and 3/8" Cable	1
12-0454	DHBG	Down Head Boring Gimlet • Goes down waste, not up the stack For 5/16" and 3/8" Cable	1
12-0456	SHD	Spear Head Starting Drill For 5/8" and 3/4" Cable	1
12-0458	RTR-1	Small Corkscrew Retrieving Tool For removing loose objects For 3/8" and 1/2" Cable	1
12-0510	HECS	Cutter Set	1
12-0512	MRCS	Cutter Set	1
12-0520	EFC	3/8" Female Connector	1
12-0522	EMC	3/8" Male Connector	1
12-0500	SOQ	Quart Snake Oil	1

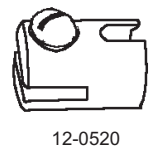
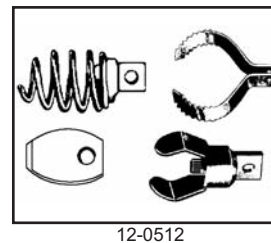
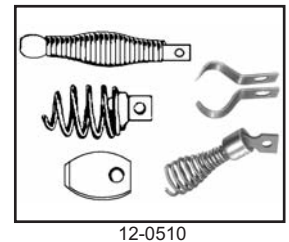
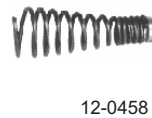
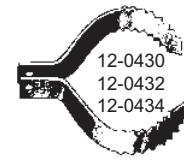
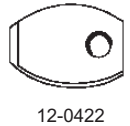
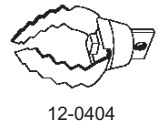
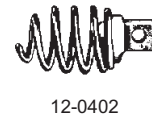
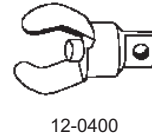

**GENERAL WIRE**

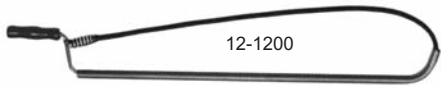

12-1200

12-1202  
12-1204



12-1230  
12-1234



12-1252



12-1262



12-1270  
12-1272



12-1282  
12-1284



12-1292



12-1296



12-1310

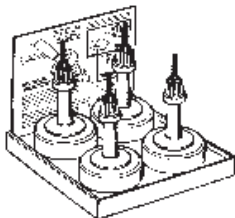

12-1312



12-1320



12-7240

ITEM NO.	MFG.	DESCRIPTION	CTN. QTY.
12-1200	3NKH	Economy 3/8" x 36" Bright spring wire auger with Galvanized steel tube and covered bend and wood handle	12
12-1202	3RB	7/16" x 36" Bright spring wire auger with Galvanized steel tube & covered bend & wood handle	12
12-1204	3PJH	1/2" x 34" Bright spring wire auger with Galvanized steel tube & covered bend & heavy vinyl grip handle	6
12-1230	3FL	1/2" x 36" Flexicore Professional auger two layers of spring wire • aluminum handle	6
12-1234	T6FL	Teletube closet auger with push button extension from 3 to 6 feet	6

**DRILL SNAKE**

12-1252	DS-25	25ft Snake encased in a plastic tube that remains stationary as the snake is rotated by an electric drill	6
---------	-------	---	---

**HAND-HELD CANISTER SNAKES**

12-1262	CP25SM	1/4" x 25ft. Power Spin-Thru can be attached to an electric Drill (Steel Container)	6
12-1270	25-1	1/4" x15ft. Steel container with collet chuck	1
12-1272	25-2	1/4" x25ft. Steel container with collet chuck	1
12-1282	P15SM	1/4" x 15ft. Steel drum Spin-Thru with T Grip	6
12-1284	P25SM	1/4" x 25ft. Steel drum Spin-Thru with T Grip	6
12-1290	15PL	1/4" x 15ft. Plastic Spin-Thru	6
12-1292	25PL	1/4" x 25ft. Plastic Spin-Thru	6
12-1296	C-25PL	1/4" x 25ft. Plastic Spin-Thru with drill attachment for an electric drill	6
12-1310	D41020N	1/4" x 20ft. Hempe Pulse Auger	4
12-1312	D41020N	1/4" x 20ft. Hempe Pulse Auger (Display Carton 4 pcs.) 1Unit = 4pcs.	1
12-1314	D41022N	1/4" x 20ft. Hempe Pulse Auger Refill Only	1
12-1320	CS-254	1/4" x 25ft. Comet Top Snake with patented crawl head	6
12-7240	CRCS-254	1/4" x 25ft. Comet Refill only	1



**GENERAL WIRE  
DRAIN CLEANING MACHINES**

ITEM NO.	MFG.	DESCRIPTION	CTN. QTY.
12-1500	BDJ	1/4" x 25ft. Drain King Sure-grip Chuck • Aluminum drum • Double insulated • vari-speed motor • 22lbs.	1
12-1510	SV-B-WC	Super-Vee Unit in metal case 1/4" x 25ft. & 3/8" x 35ft. Flexicore cables • 5 piece cutter set • Slide action chuck • Vari-speed motor with reverse • Additional cartridge • 34lbs.	1
12-1512	SV-F	Super-Vee Less case 1/4" x 25ft. with EI Basin Plug Head • Slide action chuck • Vari-speed motor with reverse • 13lbs.	1
12-1520	LMB	Little Mike™ 5/16" x 50ft. Flexicore cable • Steel frame • Air switch • Double insulated motor • Lite weight 28lbs.	1

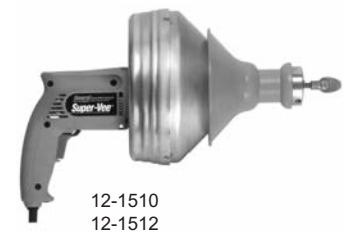

**MARCO  
PIPE CLEANING TOOLS**

12-1600	H500-A	1/4" x 25ft. Hand held canister drum unit with MPG chuck operates with any standard 3/8" or 1/2" variable speed hand drill (up to 1200 rpm max.)	1
12-1602	H500-D	3/8" x 35ft. Hand held canister drum unit with MPG chuck • operates with any standard 3/8" or 1/2" variable speed hand drill (up to 1200 rpm max.)	1

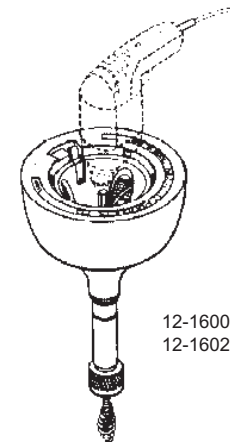

**GENERAL WIRE  
DRAIN CLEANING MACHINES**



ITEM NO.	MFG.	DESCRIPTION	CTN. QTY.
----------	------	-------------	-----------

**HAND UNIT**

12-1522	450FL2-DH	Spin-Drive 3/8" x 50ft. Flexicore cable with down head • drum has a large crank handle on the back • 34lbs.	1
---------	-----------	---	---

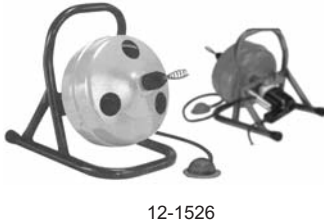

**ELECTRIC UNIT**

12-1526	MI50AC	Micro-Rooter™ 3/8" x 50ft. Flexicore cable • with chuck • vari-speed motor	1
---------	--------	--	---



12-1540	MR-B	Mini-Rooter™ 3/8" x 75ft. Flexicore cable • 4-Piece cutter set • 10ft. power cord • Ground fault interrupter • Water proof air switch • Leather gloves • 68lbs.	1
---------	------	---	---



12-1542	MR308D	Mini-Rooter foot peddle only	1
---------	--------	------------------------------	---

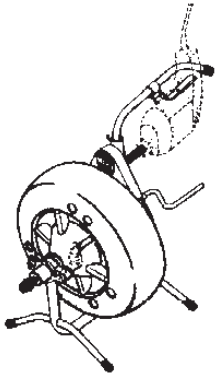

**MARCO  
PIPE CLEANING TOOLS**

12-1604	F300-A	3/8" x 50ft. Floor model canister drum unit with MPG chuck • operates with any standard 3/8" or 1/2" variable speed hand drill (up to 1200 rpm max.)	1
---------	--------	---	---