

## INLINE FILTERS

ITEM	PACK	DESCRIPTION	GAL LIFE
<div style="border: 1px solid black; padding: 5px; text-align: center; width: 40px; height: 40px; margin: 0 auto;"> <b>T</b> TASTE                 </div>	37-1817	SKIN 2" x 6" Ice Maker • 1/4" Compression	1000 Gallons
	37-1819	BOX 2" x 10" Ice Maker • 1/4" Quick Connect	2000 Gallons
	37-1820	BULK 2" x 10" RO Post-Filter • 1/4" FIP	1500 Gallons
	37-1821	BOX 2" x 10" Ice Maker • 1/4" Compression	2000 Gallons
	37-1813	SKIN 2" x 10" Inline Filter • 3/8" Compression	2000 Gallons
	37-1815	SKIN Shower Head Filter • 1/2" FIP x 1/2" MIP 100% KDF-55 for Reduction of Chlorine and Foul Odors	10000 Gallons
37-1825	SKIN 2" x 10" RV Filter • 3/4" Hose Thread	2000 Gallons	
<div style="border: 1px solid black; padding: 5px; text-align: center; width: 40px; height: 40px; margin: 0 auto;"> <b>C</b> CHEMICAL                 </div>	37-1827	SKIN 2-1/2" x 11" • 1/4" FIP Lead Safe • Listed & Tested NSF® 53 • Reduces Lead, CYST, Chlorine and Odors • Especially Designed for Water Fountains in Schools, Parks, etc.	750 Gallons/ 6-12 Gallons
<div style="border: 1px solid black; padding: 5px; text-align: center; width: 40px; height: 40px; margin: 0 auto;"> <b>D</b> DELIMER                 </div>	37-1823	BOX 2" x 10" Ice Maker with Delimer	2000 Gallons
	37-1811	SKIN 2" x 6" Phosphate / Carbon • 1/2" MIP	2000 Gallons
	37-1829	SKIN 2" x 6" Phosphate / Carbon • 1/4" Compression	1250 Gallons

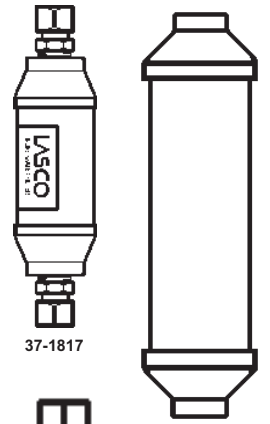

37-1813  
37-1821  
37-1823

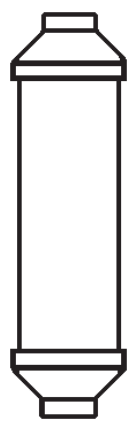

37-1819  
37-1820  
37-1827

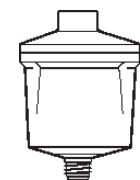

37-1815



37-1825



37-1811

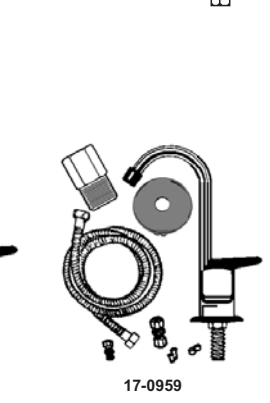

37-1829

## INLINE FILTERS KITS

<div style="border: 1px solid black; padding: 5px; text-align: center; width: 40px; height: 40px; margin: 0 auto;"> <b>T</b> TASTE                 </div>	37-1831	SKIN Ice Maker Filter with 15' Copper Tubing Installation Kit	1250 Gallons
	37-1833	SKIN Ice Maker Filter with 7" Braided Flex Installation Kit	1250 Gallons

## ICEMAKER INSTALLATION KITS

17-0951	SKIN	25' Poly Tubing for Icemaker Installation
17-0951P	BAG	
17-0953	SKIN	25' Copper Tubing for Icemaker Installation
17-0957	SKIN	Poly Tube Icemaker Install Kit • Uses #44 EZ Adapter Not Saddle Valve
17-0959	SKIN	7' Braided Stainless Install Kit • Uses #44 EZ Adapter Not Saddle Valve

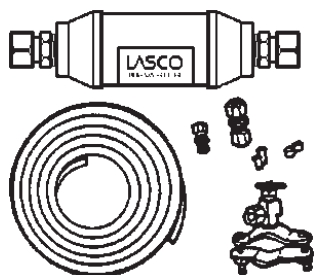

37-1831

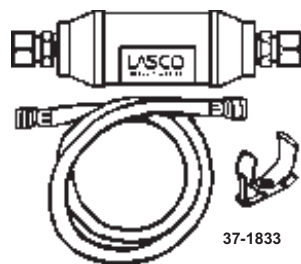

37-1833



17-0951  
thru  
17-0953

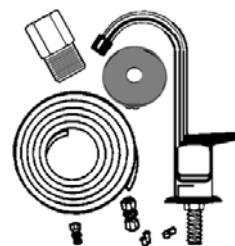

17-0957

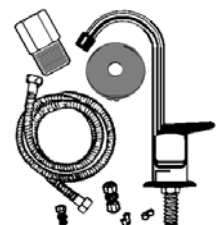

17-0959





**REMOVES DIRT, RUST & SEDIMENT**

ALL CARTRIDGES FIT STANDARD OR SLIMLINE 10" FILTER HOUSINGS WITH THE EXCEPTION OF THE "JUMBO BLUE" CARTRIDGE WHICH IS 4-1/2" x 9-7/8" AND FITS LARGE HEAVY DUTY HOUSINGS.

- Whole House
- Point of Use
- RO Pre-Filter

**SEDIMENT MICRON RATES**

<b>RATES</b>	<b>FILTERS</b>	<b>RATES</b>	<b>FILTERS</b>
1 MICRON	VERY FINE	30 MICRON	MEDIUM/COARSE
5 MICRON	FINE	50 MICRON	COARSE
20 MICRON	MEDIUM		

**PAP PAPER PLEATED CELLULOSE RESIN IMPREGNATED MEDIA**

- Point of Use or Whole House Filter
- Most Economical & Common Household Filter
- Standard Size • Fits all Standard 10" Housings • 2-5/8" O.D. x 9-7/8" Length
- 20 Micron



**POS POLY SPUN POLYPROPYLENE SPUN WOUND FILTER MEDIA**

- Carefully Spun Together for True Gradient Depth Filtration
- RO Pre-Filter, Point of Use or Whole House Filter
- Standard Size • Fits all Standard 10" Housings • 2-5/8" O.D. x 9-7/8" Length
- 1 / 5 / 20 / 50 Micron Rated



**POW POLY WOUND FILTER MEDIA**

- Polypropylene Wound String
- Point of Use or Whole House Filter
- Standard Size • Fits all Standard 10" Housings • 2-5/8" O.D. x 9-7/8" Length
- 30 Micron Rated

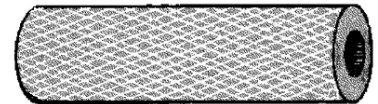

**POP POLYESTER PLEATED MEDIA**

- Commercial Grade • Washable and Reusable
- RO Pre-Filter, Point of Use or Whole House Filter
- Standard Size • Fits all Standard 10" Housings • 2-5/8" O.D. x 9-7/8" Length
- "JUMBO BLUE" • Fits Heavy Duty size Housings • 4-1/2" O.D. x 9-7/8" Length
- 5 / 20 / 50 Micron Rated



ITEM	PACK	TYPE	MEDIA	DESCRIPTION	MICRON	RATING
37-1860	BULK/24	PAP20	Paper Pleated	Medium Rust/Sediment	20	H
37-1860P	SHRINK					
37-1861	CARDED					
37-1876P	SHRINK	POS1	Poly Spun	Extra Fine Rust/Sediment	1	H H
37-1878	BULK/24	POS5		Fine Rust/Sediment	5	H H
37-1878P	SHRINK					
37-1879	CARDED			RO Pre-Filter		
37-1880P	SHRINK	POS20		Medium Rust/Sediment	20	H H
37-1882P	SHRINK	POS50		Course Rust/Sediment	50	H H
37-1898P	SHRINK	POW30	Wound String	Medium/Couse Rust/Sediment	30	H H
37-1884P	SHRINK	POP5	Poly Pleated	Fine Rust/Sediment	5	H H H
37-1886P	SHRINK	POP20		Medium Rust/Sediment	20	H H H
37-1888P	SHRINK	POP50	Washable	Course Rust/Sediment	50	H H H
37-1892P	SHRINK	POPBB	Reusable	Course • "JUMBO BLUE" Large 4-1/2" O.D. x 9-7/8" Length	50	H H H

★ = GOOD

★★ = BETTER

★★★ = BEST

**NOTE: Bulk Cartridges will be sold only by the case**



**REMOVES FOUL TASTE, ODORS, & CHLORINE**

ALL CARTRIDGES FIT STANDARD OR SLIMLINE 10" FILTER HOUSINGS WITH THE EXCEPTION OF THE "JUMBO BLUE" CARTRIDGE WHICH IS 4-1/2" x 9-7/8" AND FITS LARGE HEAVY DUTY HOUSINGS.

- Use for Water Dispensers
- RO Post or Pre-Filters
- Whole House

**MEDIA**

Bituminous Carbon 12 x 40 Carbon • Reduces Bad Taste, Odors, & Chlorine • RO Pre-Filter  
 Bituminous Carbon 20 x 50 Carbon • Reduces Bad Taste, Odors, & Chlorine • RO Post-Filter  
 Coconut Shell Carbon • 20 x 50 Water Washed • Reduces Bad Taste, Odors & Chlorine • RO Pre-Filter  
 KDF-55 • Generally used with other Carbon Media • Excellent Chlorine Reduction

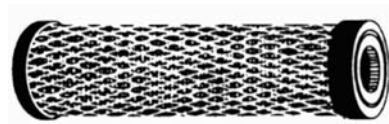

**CARBON IMPREGNATED PAPER**

- Plastic End Caps
- Poly Outer Sheath
- Most Economical
- Most Common Household Filter

**CAP**



**GRANULAR CARTRIDGES FILLED WITH ASSORTED MEDIAS**

- Bituminous Carbon or Coconut Shell Carbon or KDF-55
- RO Pre-Filter or Post-Filter
- Water Dispensers

**GAC**

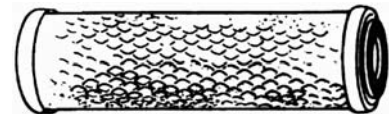

**CARBON BLOCK - ACID WASHED & FUSED**

- RO Pre-Filter
- Water Dispenser
- 5 Micron Sediment Filter

**CAB**

ITEM	PACK	TYPE	MEDIA	DESCRIPTION	TASTE	ODOR	CHLOR
37-1862P 37-1863	SHRINK CARDED	CAP1	Carbon Paper	Household Use • 5 Micron • 1000 Gallons	★	★	★
37-1864 37-1864P	BULK/25 SHRINK	GAC1	12 x 40 Acid Washed Carbon	Good For Pre-Filter • NSF Listed • 3500 Gallons	★★	★★	★★
37-1866 37-1866P 37-1867	BULK/25 SHRINK CARDED	GAC2	20 x 50 Coconut Shell Carbon	Good For Pre-Filter • NSF Listed • 5000 Gallons	★★★	★★★	★★★
37-1868 37-1868P	BULK/25 SHRINK	GAC3	20 x 50 Acid Washed Carbon	Good For Pre-Filter • Omni T-28 5000 Gallons	★★	★★	★★
37-1870P	SHRINK	GAC4	20 x 50 Carbon With KDF-55	Excellent Chlorine Removal NSF Listed • 10,000 Gallons	★★★★	★★★★	★★★★
37-1894P	SHRINK	GACBB	12 x 40 Carbon	"JUMBO BLUE" • 5600 Gallons	★★★	★★★	★★★
37-1872P	SHRINK	CAB1	Carbon Block	5 Micron • NSF Listed • 3000 Gallons	★★★★	★★★★	★★★★

★ = ADEQUATE

★★ = GOOD

★★★ = BETTER

★★★★ = BEST

**NOTE: Bulk Cartridges will be sold only by the case**



# HOUSING TYPE WATER FILTER CARTRIDGES



**REDUCES LEAD, HEAVY METALS, & CYST** (Giardia Cryptosporidium)

**CARBON BLOCK - ACTIVATED CARBON**

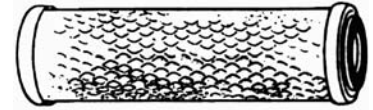

**CAB**

- Enhanced Absorption Characteristics • Will not Channel or Bypass
- Standard Size • Fits all Standard 10" Housings • 2-5/8" O.D. x 9-7/8" Length
- 99.98% Reduction of CYST



ITEM	PACK	TYPE	MEDIA	DESCRIPTION	SIZE
37-1874P	SHRINK	CAB2	Carbon Block	Reduces Lead / CYST / Bad Taste / Odor • NSF® 90% Reduction of Lead for 2500 Gal. at .75 GPM in Accordance with NSF® Protocol	9-3/4" x 2-1/2"



**REDUCES LIME SCALE & HARD WATER DEPOSITS**

**GRANULAR FILLED CARTRIDGE WITH VARIOUS MEDIA**



**GAC**

- Phosphate - A Sequestrant used to Reduce Calcium & Hardness Deposits
- Carbon - Can be Mixed with Phosphate for Reduction of Bad Taste / Odor / Chlorine



37-2550P	SHRINK	GALC1	Phosphate with Carbon	Reduces Lime / Scale / Deposits / Bad Taste / Odor	9-3/4" x 2-7/8"
37-2552P	SHRINK	GALC2	100% Phosphate	Reduces Lime / Scale / Hard Water Deposits	9-3/4" x 2-7/8"



**"E" SERIES REPLACEMENT CARTRIDGES FOR EVERPURE™**

**CARBON BLOCK - WITH PHOSPHATE & LEAD REMOVER**

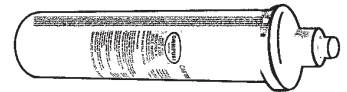

**EVP**

- For Permanent EVERPURE™ Head Systems
- Generic Replacement - Not Genuine



37-2502	BULK	H-50	Carbon Block with Phosphate	Reduces Bad Taste / Odor / Chlorine / Lime / Scale 1 Micron • 1000 Gal • 35.5 Cubic Inches	6" x 2-1/2"
37-2500	BULK	H-100		1 Micron • 2500 Gal • 35.5 Cubic Inches	12" x 2-1/2"
37-2510	BULK	H-200		1 Micron • 3000 Gal • 41 Cubic Inches	14" x 2-1/2"
37-2504	BULK	H-104	Lead Reduction Block with Phosphate	Reduces Lead / Cyst / Bad Taste / Odor / Lime / Scale 1 Micron • 1250 Gal • 28.6 Cubic Inches	10" x 2-1/2"
37-2520	BULK	H-300		1 Micron • 2000 Gal • 41 Cubic Inches	14" x 2-1/2"



**20 INCH LONG REPLACEMENT CARTRIDGE**

5 Micron Sediment and Carbon Block • 2-5/8" O.D. x 19-7/8" Length

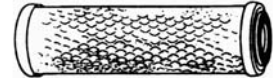

37-2560	BULK/20	POS5-20	Poly Spun	Fine Rust / Sediment	20" x 2-5/8"
37-2570	BULK/20	CAB-20	Carbon Block	10 Micron • 9000 Gallons	20" x 2-5/8"
37-2576	BULK	CAB-420	Carbon Block	Carbon • Long Jumbo	20" x 4"

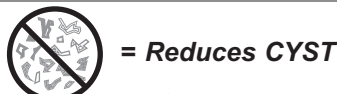

# WATER FILTER HOUSINGS

## WATER FILTER HOUSINGS ONLY

ITEM	PACK	COLOR	DESCRIPTION
37-2100P	SHRINK	WHITE	3/8" Inlet & Outlet for 9-3/4" Cartridges
37-2102P	SHRINK	CLEAR	3/8" Inlet & Outlet for 9-3/4" Cartridges
37-2150P	SHRINK	WHITE	3/4" Inlet & Outlet for 9-3/4" Cartridges
37-2152P	SHRINK	CLEAR	3/4" Inlet & Outlet for 9-3/4" Cartridges
37-2170P	SHRINK	BLUE	1" Inlet & Outlet for <b>"JUMBO BLUE"</b> Heavy Duty 10" Sump

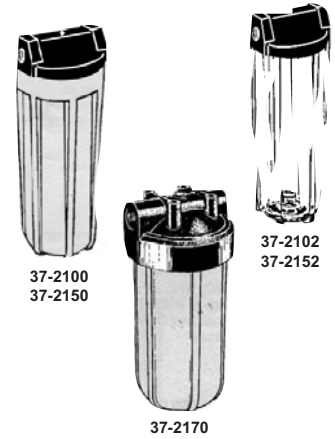

## HOUSINGS WITH FILTERS

ITEM	PACK	DESCRIPTION	TYPE
37-1850P	SHRINK	3/4" White Housing • Pleated 20 Micron Filter • Reduces Rust & Sediment	
37-1852P	SHRINK	3/8" White Housing • GAC Carbon Cartridge • Reduces Bad Taste & Odor	
37-1854	BOXED	1/4" Double White Housing with Mounting Bracket • 5 Micron Sediment Filter & GAC Coconut Carbon Filter • Reduces Bad Taste, Odor, Chlorine, & Sediment • Dispenser Faucet • Tubing & Water Supply Hook-Up	
37-1856	BOXED	1/4" Double Housing with Mounting Bracket • Lead, Cyst, Heavy Metal Reduction Filter • 5 Micron Sediment • 1 Micron Lead Reducing Carbon Block • Dispenser Faucet • Tubing & Water Supply Hook-Up	
37-1890P	SHRINK	1" Whole House "JUMBO BLUE" Heavy Duty Housing • Pleated 50 Micron Filter • Reduces Rust & Sediment	
37-1900	BOXED	1" Double Whole House "JUMBO BLUE" Heavy Duty Housing • Pleated 50 Micron Filter Sediment & GAC Carbon Filter • Reduces Bad Taste, Odor, Chlorine, & Sediment	

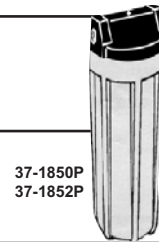



### ULTRAVIOLET WATER STERILIZER

ITEM	PACK	COLOR
37-1910	BOXED	CHROME

1/4" In/Out Port, 2 GPM Flow Rate, UV Lamp, Chrome Polished Quartz Sleeve, Mounting Brackets Included.



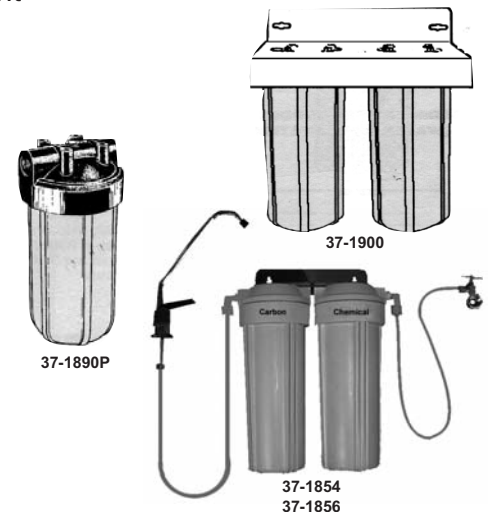

05/08/09





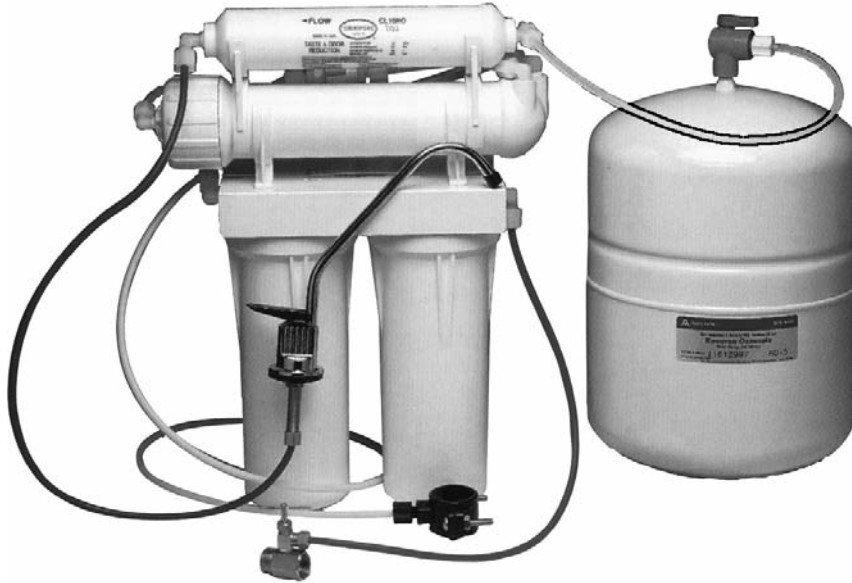

## Features of the **LASCO** Reverse Osmosis System

- 4 & 5 STAGE FILTRATION AND PURIFICATION PROCESS FOR WATER
- INCLUDES ALL FITTINGS, TUBING, & FAUCETS FOR EASY HOOK-UP •
- IMPROVES QUALITY & TASTE •

- 1 5-MICRON SEDIMENT FILTER THAT TRAPS DIRT, RUST, AND SAND PARTICLES
  - 2 CARBON PRE-FILTER REDUCES MOST ORGANIC MATERIALS, SUCH AS CHLORINE, BAD TASTES, AND ODORS FROM THE WATER. THE REVERSE OSMOSIS SYSTEM PRE-FILTER CONTAINS CARBON, ALLOWING EXTRA FILTRATION AND EXTENDING THE LIFE OF THE RO MEMBRANE.
  - 3 THIN FILM COMPOSITE (TFC) SEMIPERMEABLE MEMBRANE SEPARATES THE PURIFIED WATER FROM THE REJECTED IMPURITIES, UP TO 96% OF ARSENIC, LEAD, FLUORIDE AND DISSOLVED SOLIDS, WHICH ARE FLUSHED FROM THE MEMBRANE AND DISPOSED DOWN THE DRAIN.
  - 4 FINAL STAGE CARBON FILTER - FINAL FILTRATION STAGE FOR FURTHER REDUCTION OF MATERIALS FROM THE WATER TO ENHANCE THE FINAL TASTE.
- ▶ AUTOMATIC SHUT-OFF VALVE - WHEN THE STORAGE TANK HAS REACHED CAPACITY, THE AUTOMATIC SHUT-OFF VALVE STOPS THE FLOW OF WATER ENTERING THE SYSTEM, THEREBY CONSERVING WATER. AS WATER IS DRAINED FROM THE STORAGE TANK, THE FLOW IS ALLOWED TO RESUME THROUGH THE SYSTEM. THIS CYCLING PROCEDURE WORKS AUTOMATICALLY BY THE WATER PRESSURE.
  - ▶ OPERATES ON 40 PSI TO 85 PSI WATER LINE PRESSURE.
  - ▶ STORES UP TO 3 GALLONS OF PURIFIED WATER.
  - ▶ PRODUCES ENOUGH PURIFIED WATER FOR AN AVERAGE FAMILY'S DAILY USE.

ITEM	PALLET QTY	TYPE	DESCRIPTION
37-1936	18	18 GAL • Taste / Sediment / Chemical / Delimer	4-Stage RO System with Air Gap
37-1938	18	18 GAL • Taste / Sediment / Chemical / Delimer	4-Stage RO System without Air Gap
37-1940	18	50 GAL • Taste / Sediment / Chemical / Delimer	4-Stage RO System with Air Gap
37-1942	18	50 GAL • Taste / Sediment / Chemical / Delimer	4-Stage RO System without Air Gap
37-1946	18	50 GAL • Taste / Sediment / Chemical / Delimer	5-Stage RO System with Air Gap
37-1948	18	50 GAL • Taste / Sediment / Chemical / Delimer	5-Stage RO System without Air Gap
37-1952	18	50 GAL • Taste / Sediment / Chemical / Delimer	4-Stage RO System with pump



## COUNTERTOP WATER FILTERS

ITEM	PACK	DESCRIPTION	TYPE
37-2000	BOXED	Countertop Water Filter • Hooks up to kitchen Faucet Aerator • GAC Carbon Taste / Odor / Chlorine Cartridge	<b>T</b> TASTE
37-2002	BOXED	Countertop Filter • Hooks up to Kitchen Faucet Aerator • Lead Reducing Carbon Block • Reduces Lead, Cyst, Heavy Metals, Sediments, Odors & Chlorine	<b>C</b> CHEMICAL
37-2050	BOXED	End of Faucet Filter • Hooks to the end of Kitchen Spout • Water Diverts from Standard Flow to Filtered Water	<b>T</b> TASTE
37-2060	BOXED	Cartridge for end of Faucet Filter	<b>T</b> TASTE
37-2061	CARDED	Above	<b>T</b> TASTE

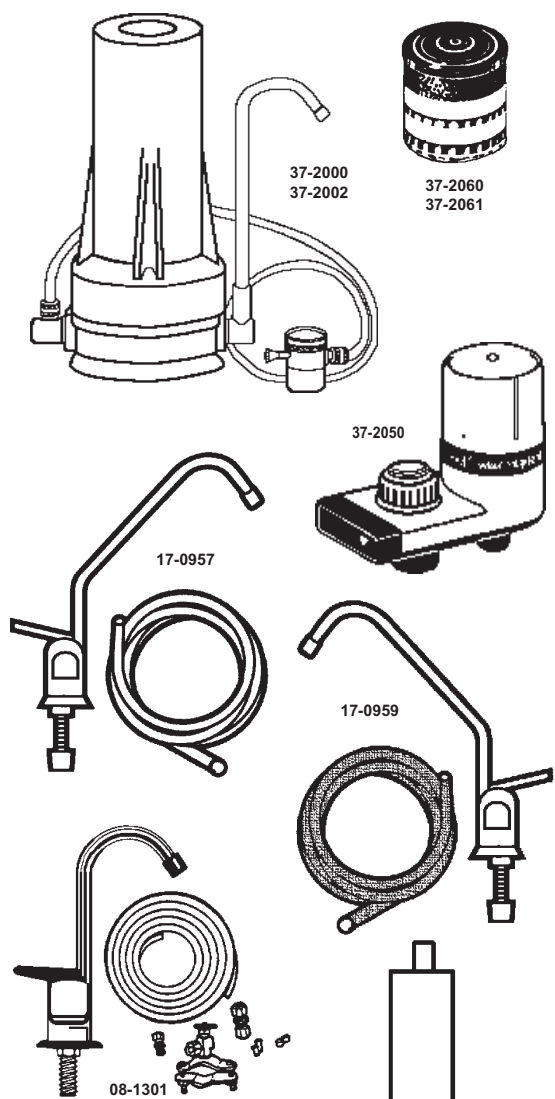

## HOUSING TYPE WATER FILTER INSTALLATION KITS

ITEM	PACK	DESCRIPTION
17-0957	CARDED	1/4" Poly Tubing Installation Kit for 3/8" Housing Type Filter • Includes Faucet, Tubing, and all necessary Fittings
17-0959	CARDED	Braided Flex Tubing Installation Kit for 3/8" Housing Type Filter • Includes Faucet, Tubing, and necessary Fittings
08-1301	CARDED	1/4" Poly Tubing Installation Kit for 3/8" Housing Type Filter • Includes Faucet, Tubing, and all necessary Fittings

## FILTERS FOR FAUCET'S WITH FILTERS BUILT INTO KITCHEN FAUCET'S

ITEM	PACK	DESCRIPTION
37-2580	BULK	Price Pfister 941-290 Filter
37-2590	BULK	Moen • Micro Tech 1000 • Taste
37-2594	BULK	Moen • Micro Tech 5000 • Lead / Cyst
09-6136	BULK	Grohe Pull-Out Filter

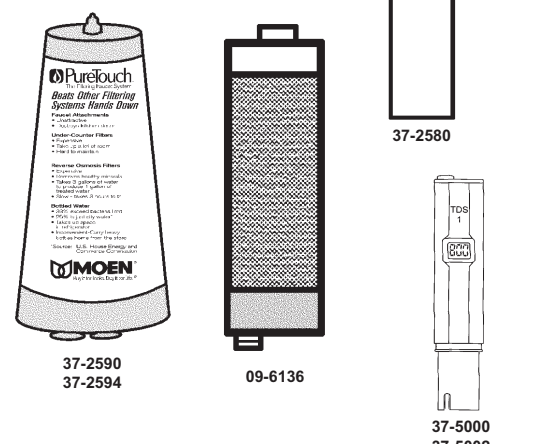

## DRINKING WATER TEST KITS

ITEM	PACK	DESCRIPTION
37-5000	BOXED	TDS Tester • Test for Total Desolved Solids
37-5002	BOXED	PH Tester • Test for PH Levels
37-5050	CARDED	Chlorine / Hardness Test Kit
37-5052	CARDED	Lead Test Kit
37-5054	CARDED	Pesticide Test Kit
37-5058	CARDED	All in One Test Kit • Test for Pesticides, PH, Nitrates, Chlorine, Hardness, Iron & Lead



08/28/01



**DISPENSER FAUCETS • ALL WATER DISPENSER FAUCETS ARE LOW LEAD • NSF 61 COMPLIANT**

ITEM	PACK	DESCRIPTION
08-1303	CARDED	Chrome Plated 6" Standard Faucet
08-1307	CARDED	Chrome Plated 10" Long Reach Faucet
08-1331	CARDED	Chrome Plated Hot & Cold Dispenser Faucet
08-1337	CARDED	Chrome Plated ¼ Turn Ceramic Dispenser Faucet
08-1339	CARDED	White Plated ¼ Turn Ceramic Dispenser Faucet
08-1341	CARDED	Chrome Plated Air Gap Dispenser Faucet

Note: For Special Finish Dispenser Faucets, See Page 07-15

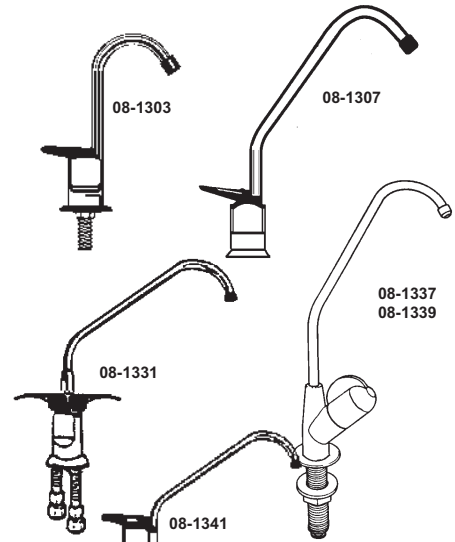

**DISPENSER FAUCETS KITS & PARTS**

ITEM	PACK	DESCRIPTION
08-1261	CARDED	Dispenser Faucet Repair Kit
08-1267	CARDED	Dispenser Faucet Black Handle & Spout Tip
08-1269	CARDED	Dispenser Faucet White Handle & Spout Tip
08-1280	BULK	Shank Extender For Dispenser Faucet
08-1281	CARDED	Same as above - No Lead Material

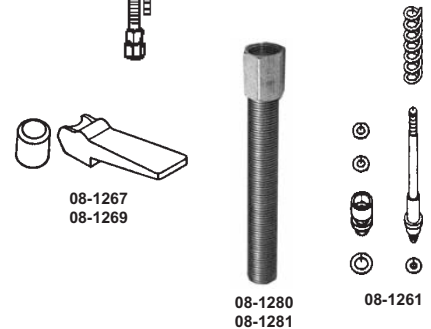

**AERATOR DIVERTER VALVES**

ITEM	PACK	DESCRIPTION
09-2125	CARDED	1/4" Single Barb
09-2131	CARDED	1/4" Double Barb
09-2135	CARDED	3/8" Single Barb

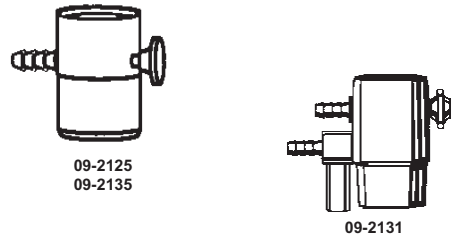

**WRENCHES & MISCELLANEOUS**

ITEM	PACK	DESCRIPTION
37-2252	BULK	Standard Housing Wrench
37-2253	CARDED	Standard Housing Wrench
37-2256	BULK	"BIG BLUE" Housing Wrench
37-2250	BULK	Cartridge Coupler • For Joining Two 10" Cartridges in a 20" Long Sump

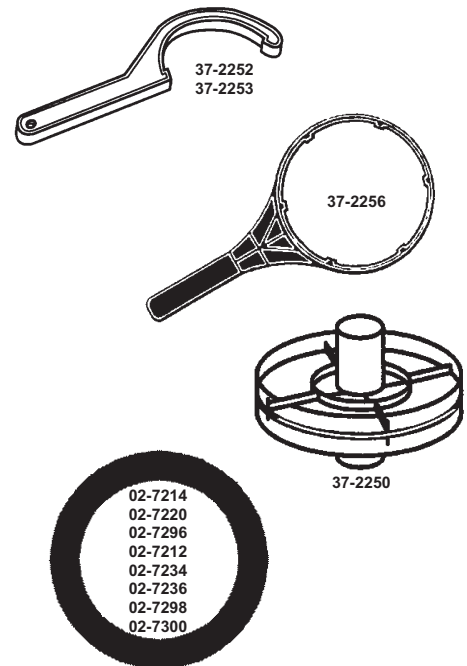

**O-RINGS**

ITEM	PACK	DESCRIPTION
02-7215	BULK	O-Ring for Slimline / Plymouth 3-3/8 x 3-5/8 x 1/8
02-7220	BULK	O-Ring for Amtek Full Size 3-3/4 x 4 x 1/8
02-7212	BULK	O-Ring for LASCO / Hydro-Flo 3-1/4 x 3-1/2 x 1/8
02-7234	BULK	O-Ring for LASCO / Easy-Well 3-7/16 x 3-5/8 x 5/32
02-7236	BULK	O-Ring for LASCO / Membrane Housing 2-3/16 x 2-7/16 x 1/8
02-7296	BULK	O-Ring for "Big Blue"/Easy-Well 5-3/8 x 5-5/8 x 1/8
02-7300	BULK	O-Ring for "Big Blue"/Plymouth 5.39 ID x .16 Wall
02-7298	BULK	O-Ring for "Big Blue"/Amtek 5-1/2 ID x 5-7/8 OD

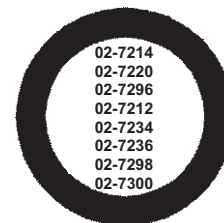



**VALVES & ADAPTERS**

ITEM	PACK	DESCRIPTION
17-0600	BULK	1/4" Compression Self Piercing Saddle Valve
17-0601	CARDED	1/4" Compression Self Piercing Saddle Valve
17-0651	CARDED	"C" Clamp Style Saddle Valve with 1/4" Comp. Outlet
17-0936	BULK	1/4" Tube x 1/4" FIP Angle Chrome Plated
17-0937	CARDED	1/4" Tube x 1/4" FIP Angle Chrome Plated
17-0938	BULK	1/4" Tube x 1/8" MIP Angle Chrome Plated
17-0939	CARDED	1/4" Tube x 1/8" MIP Angle Chrome Plated
17-0942	BULK	1/4" Tube x 1/4" MIP Straight Chrome Plated
17-0943	CARDED	1/4" Tube x 1/4" MIP Straight Chrome Plated
17-8438	BULK	7/16"-1/2" SJ #44 EZ Adapter with 1/8" Tap
17-8439	CARDED	7/16"-1/2" SJ #44 EZ Adapter with 1/8" Tap
17-8383	CARDED	7/16"-1/2" SJ #44 EZ Adapter with 1/4" Angle Valve
17-8387	CARDED	3/4" FHT x 1/4" 90° Compression Valve
17-8440	BULK	Plastic EZ Adapter with 1/4 QC
17-8441	CARDED	Plastic EZ Adapter with 1/4 QC
17-6758	BULK	1/4" Female Compression x 3/8" Male Compression
17-6759	CARDED	1/4" Female Compression x 3/8" Male Compression
17-6754	BULK	3/8" Female Compression x 1/4" Male Compression
17-6755	CARDED	3/8" Female Compression x 1/4" Male Compression
17-6760	BULK	1/2" Female Compression x 3/8" Male Compression
17-6761	CARDED	1/2" Female Compression x 3/8" Male Compression
06-9101	CARDED	3/8" Female Comp x 1/4" Comp Outlet Tee
06-9111	CARDED	3/8" Female Comp x 1/4" Comp Outlet Tee
06-9117	CARDED	1/2" Female SJ x 1/4" Comp Outlet Tee
06-9121	CARDED	1/2" Female SJ x 1/4" Comp Outlet Tee
10-0011	CARDED	1/4" Female Comp x 1/2" Male Adapter
10-0013	CARDED	3/8" Female Comp x 1/2" Male Adapter
10-0015	CARDED	7/16" Female Comp x 1/2" Male Adapter
10-0017	CARDED	1/2" Female Comp x 1/2" Male Adapter

**BRACKETS**

ITEM	PACK	DESCRIPTION
37-2200	BULK	2" Ice Maker Filter Bracket
37-2201	CARDED	2" Ice Maker Filter Bracket
37-2202	BULK	2-1/2" Inline Filter Bracket
37-2203	CARDED	2-1/2" Inline Filter Bracket
37-2204	BULK	2-1/2" x 2" Combo Filter Bracket
37-2211	CARDED	U Bracket for Slimline Filters
37-2212	BULK	Single Bracket for Slimline Filters
37-2213	CARDED	Single Bracket for Slimline Filters
37-2214	BULK	Double Bracket for Slimline Filters
37-2216	BULK	Single Bracket for Jumbo Filters
37-2218	BULK	Double Bracket for Jumbo Filters

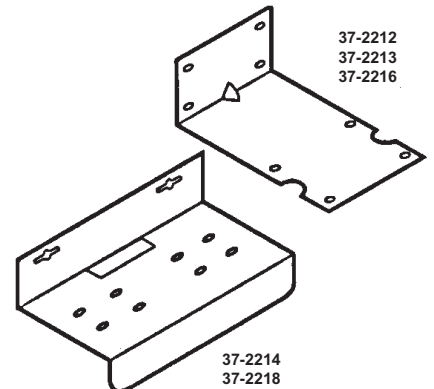
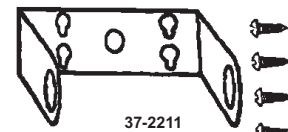
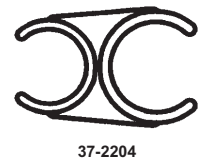
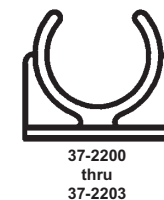
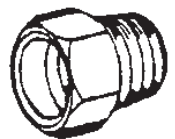
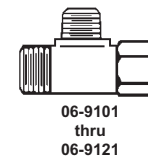
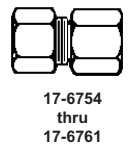
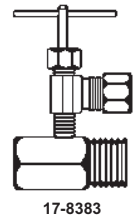
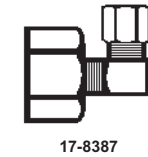
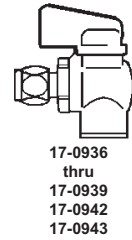
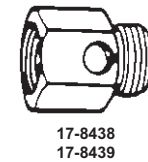
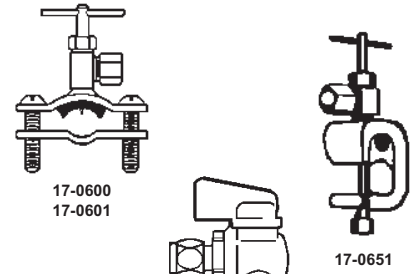

**TUBING & HOSE**

**STAINLESS STEEL • 1/4" FEMALE COMPRESSION**

ITEM	PACK	DESCRIPTION
10-0944	CARDED	1/4" x 1/4" x 12" Braided Flex
10-0946	CARDED	1/4" x 1/4" x 2 Ft. Braided Flex
10-0950	CARDED	1/4" x 1/4" x 5 Ft. Braided Flex
10-0954	CARDED	1/4" x 1/4" x 10 Ft. Braided Flex
10-0958	CARDED	1/4" x 1/4" x 20 Ft. Braided Flex

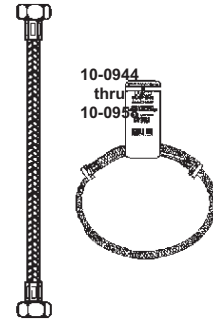

**POLY TUBING • 1/4" BULK**

ITEM	PACK	DESCRIPTION	LENGTH
16-1470	BULK	1/4" POLY "Milky" Tubing	100 feet
16-1478	BULK	1/4" POLY "Milky" Tubing	100 feet
16-1480	DISPENSER BOX	1/4" POLY "Milky" Tubing	100 feet
16-5000	SPOOL	1/4" POLY "Milky" Tubing	400 feet
16-6000	BULK	1/4" POLY "White" Tubing	100 feet
16-6002	BULK	1/4" POLY "Red" Tubing	100 feet
16-6004	BULK	1/4" POLY "Blue" Tubing	100 feet
16-6006	BULK	1/4" POLY "Yellow" Tubing	100 feet

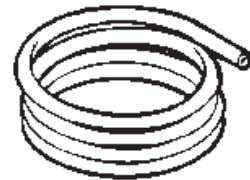

16-1470  
16-1478  
16-6000  
thru  
16-6006

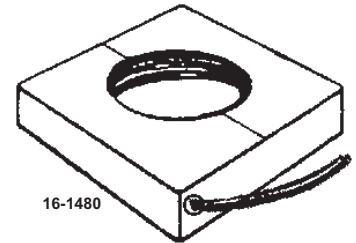

16-1480

**COPPER • 1/4" BULK**

ITEM	PACK	DESCRIPTION	LENGTH
18-0262	BULK	1/4" Utility Copper Tubing	10 feet
18-0262L	SHRINK	1/4" Utility Copper Tubing	10 feet
18-0266	BULK	1/4" Utility Copper Tubing	15 feet
18-0266L	SHRINK	1/4" Utility Copper Tubing	15 feet
18-0270	BULK	1/4" Utility Copper Tubing	25 feet
18-0270L	SHRINK	1/4" Utility Copper Tubing	25 feet
18-0272	BULK	1/4" Utility Copper Tubing	50 feet
18-0272L	SHRINK	1/4" Utility Copper Tubing	50 feet

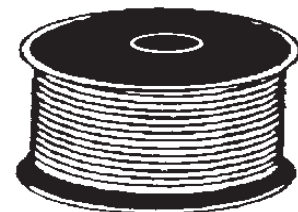

16-5000



18-0262  
thru  
18-0272L



## SPECIAL PARTS VALVES

ITEM	PACK	DESCRIPTION
17-0560	BULK	1-1/2" Tubular x 1/4" Comp RO Discharge Saddle
17-0561	CARDED	1-1/2" Tubular x 1/4" Comp RO Discharge Saddle
17-0562	BULK	1-1/2" Tubular x 3/8" Comp RO Discharge Saddle
17-0563	CARDED	1-1/2" Tubular x 3/8" Comp RO Discharge Saddle
37-2300	BULK	1/4" Line • RO Drain Adapter for use with Garbage Disposal
37-2302	BULK	3/8" Line • RO Drain Adapter for use with Garbage Disposal
37-2360	BULK	1/4" Compression RO Shut-Off Valve
37-2361	CARDED	1/4" Compression RO Shut-Off Valve

**37-2380 | BULK | 3800 Gallon Meter Valve • 100 Gal Increments**

19-5620	BULK	1/4" x 1/8" Comp x MIP Straight Check Valve
19-5621	CARDED	1/4" x 1/8" Comp x MIP Straight Check Valve
19-5622	BULK	1/4" x 1/8" Comp x MIP 90° Check Valve
19-5623	CARDED	1/4" x 1/8" Comp x MIP 90° Check Valve
<b>32-3202</b>	<b>BULK</b>	<b>1/8" x 1/8" MIP x MIP Stainless Steel Straight Check Valve</b>

## REPLACEMENT FILTER KITS

**37-2370P | BAGGED | RO Triple Pack Replacement Cartridge Kit Includes:**  
 1 each 37-1878 Sediment Prefilter  
 1 each 37-1864 Carbon GAC Prefilter  
 1 each 37-1820 Polish Postfilter

**37-2372P | BAGGED | RO Triple Pack Replacement Cartridge Kit Includes:**  
 1 each 37-1878 Sediment Prefilter  
 1 each 37-1872 Carbon GAC Prefilter  
 1 each 37-1820 Polish Postfilter

## R.O. MEMBRANES, TANKS & RESTRICTORS

37-2390	BULK	15 Gallons Per Day TFC Membrane for LASCO RO
37-2392	BULK	25 Gallons Per Day TFC Membrane for LASCO RO
37-2394	BULK	50 Gallons Per Day TFC Membrane for LASCO RO

<b>37-2352</b>	<b>BULK</b>	<b>180 ML. 1/4" In-Line Restrictor</b>
<b>37-2354</b>	<b>BULK</b>	<b>400 ML. 1/4" In-Line Restrictor</b>
<b>37-2388</b>	<b>BULK</b>	<b>RO Membrane Housing</b>

37-2410	BOXED	3.2 Gallon Metal Tank
37-2420	BOXED	5 Gallon Metal Tank
37-2422	BOXED	14 Gallon Metal Tank

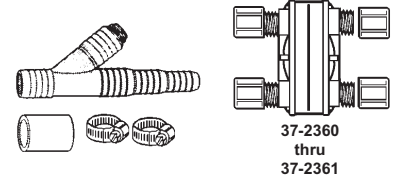
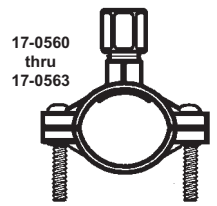

37-2300  
37-2302

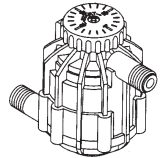

37-2380



19-5620  
19-5621

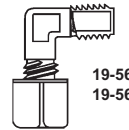

19-5622  
19-5623



32-3202

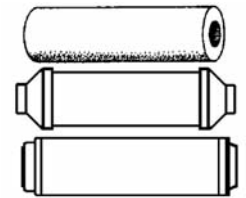

37-2370P

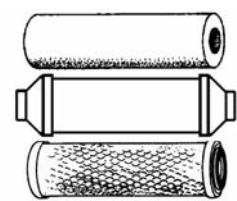

37-2372P

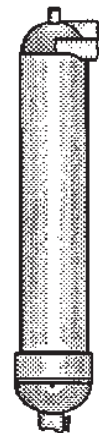

37-2388



37-2410  
37-2420  
37-2422

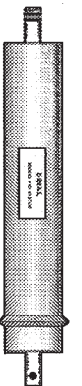

37-2390  
37-2392  
37-2394



37-2352 & 37-2354





**SEDIMENT FILTERS**

<u>LASCO</u>	<u>AMETEK</u>	<u>AMERICAN PLUMBER</u>	<u>FLOTEC</u>	<u>OMNI</u>	<u>ACE</u>	<u>MASTER PLUMBER</u>	<u>WATER PIK</u>
37-1860P	S1	W20CL	RS-2	RS-1	49641	614-800	-
37-1878P	P5	W5P	RS-3	-	45331	-	IR-20
37-1880P	P25	W25P	-	-	-	-	-
37-1882P	-	CW-50	RS-1	-	-	-	-
37-1886P	R30	W30PE	-	-	-	-	-
37-1888P	R50	W50PE	RS-1	-	-	-	-
37-1892P	R50-BBS	W50PHEHD	RS-4	RS-6	49563	852-582	-



**TASTE & ODOR FILTERS**

<u>LASCO</u>	<u>AMETEK</u>	<u>AMERICAN PLUMBER</u>	<u>FLOTEC</u>	<u>OMNI</u>	<u>ACE</u>	<u>MASTER PLUMBER</u>	<u>WATER PIK</u>
37-1862P	C-1	W5C1P	T-1	T01-S	59642	583-377	IR-40
37-1864P	GAC-10	WGC	T02	GAC-1	-	-	-
37-1866P	CC-10	WCC	-	-	49640	826-746	AP-117
37-1894P	GACBBS	WCCHD	-	-	48169	-	-
37-1872B	CBS-10	W5CB	-	-	-	-	-



**CHEMICAL**

<u>LASCO</u>	<u>AMETEK</u>	<u>AMERICAN PLUMBER</u>	<u>FLOTEC</u>	<u>OMNI</u>	<u>ACE</u>	<u>MASTER PLUMBER</u>	<u>WATER PIK</u>
37-1874	CMR-10R	WLC-R	LC-1	TC3S	48167	852-657	-





# JACO NYLON VIBRA-PRUF® FITTINGS

ALL FITTINGS COME WITH STANDARD 1 PIECE INTEGRAL SLEEVE NUT

## INSTALLATION INSTRUCTIONS FOR JACO TUBE FITTINGS

- 1 Cut the tubing end squarely and remove the internal and external burrs.
- 2 Insert the tubing through the back of the nut all the way through the nut assembly to the tube stop in the fitting body (see illustration). If the tubing does not enter the nut easily, loosen the nut one turn and then insert the tubing all the way to the tube stop in the fitting body.
- 3 Turn the nut hand tight.
- 4 Wrench tighten the nut 1-1/2 - 2 turns.
- 5 All nuts must be retightened when the system reaches projected operating temperature.

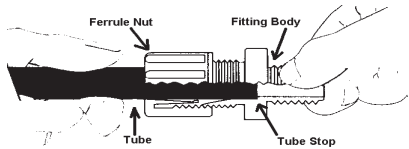

**NOTE:** Squeaking sound when tightening nut is normal. For pipe threaded connections, Teflon Tape\* must be used.  
\*Dupont's Reg. T.M. Patent 1983



**FERRULE NUT**  
With integral sleeve  
low pressure applications  
all types of tubing



**FERRULE NUT**  
With plastic gripper for use with plastic tubing for sure grip  
\*220 P.S.I.



**FERRULE NUT**  
With stainless steel gripper for use with hard & smooth surfaced tubing  
\*220 P.S.I.

## ASSEMBLY INSTRUCTIONS FOR JACO NUTS

PLEASE FOLLOW THESE DIAGRAMS IN ASSEMBLING NUTS. AS SHOWN BELOW, INSERT GRIPPER (B) INTO NUT (A). PUSH SLEEVE (C) INTO NUT ASSEMBLY.

**NOTE: IT IS NOT NECESSARY TO DISASSEMBLE THIS FITTING FOR APPLICATION. MERELY INSERT TUBING TO STOP AND TIGHTEN SEAL.**

### SG NUT ASSEMBLY

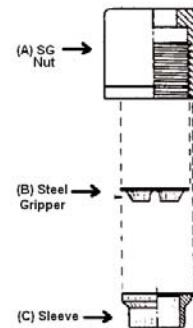

### PG NUT ASSEMBLY

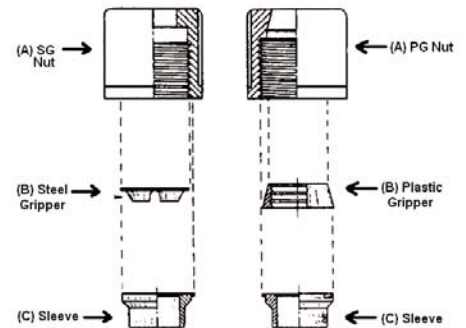

## FITTINGS

ITEM	DESCRIPTION	BULK	QTY	CARDED	QTY
<b>MALE ADAPTERS • Comp x MIP</b>					
1/4 O.D. Tube x 1/8 MIP	Integral Sleeve	19-5002	10	19-5003	6
1/4 O.D. Tube x 1/4 MIP	Integral Sleeve	19-5004	10	19-5005	6
1/4 O.D. Tube x 3/8 MIP	Integral Sleeve	19-5006	10	19-5007	6
3/8 O.D. Tube x 1/8 MIP	Integral Sleeve	19-5012	10	19-5013	6
3/8 O.D. Tube x 1/4 MIP	Integral Sleeve	19-5014	10	19-5015	6
3/8 O.D. Tube x 3/8 MIP	Integral Sleeve	19-5016	10	19-4017	6
3/8 O.D. Tube x 1/2 MIP	Integral Sleeve	19-5018	10	19-5019	6
1/2 O.D. Tube x 1/4 MIP	Integral Sleeve	19-5022	10	19-5023	6
1/2 O.D. Tube x 3/8 MIP	Integral Sleeve	19-5024	10	19-5025	6
1/2 O.D. Tube x 1/2 MIP	Integral Sleeve	19-5026	10	19-5027	6
5/8 O.D. Tube x 3/8 MIP	S.S. Gripper Sleeve	19-5028	10	19-5029	6
5/8 O.D. Tube x 1/2 MIP	S.S. Gripper Sleeve	19-5030	10	19-5031	6
7/8 O.D. Tube x 3/4 MIP	S.S. Gripper Sleeve	19-5036	10	19-5037	6

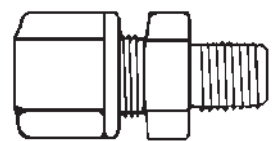

19-5002  
thru  
19-5019



# JACO NYLON VIBRA-PRUF® FITTINGS

ALL FITTINGS COME WITH STANDARD 1 PIECE INTEGRAL SLEEVE NUT

DESCRIPTION	BULK	QTY	CARDED	QTY
<b>UNIONS • Comp x Comp</b>				
1/4 O.D. x 1/4 O.D. Tube Integral Sleeve	19-5040	10	19-5041	6
3/8 O.D. x 3/8 O.D. Tube Integral Sleeve	19-5044	10	19-5045	6
1/2 O.D. x 1/2 O.D. Tube Integral Sleeve	19-5046	10	19-5047	6
5/8 O.D. x 5/8 O.D. Tube S.S. Gripper Sleeve	19-5048	10	19-5049	6
7/8 O.D. x 7/8 O.D. Tube S.S. Gripper Sleeve	19-5050	10	19-5051	6
1/4 O.D. x 1/8 O.D. Tube Integral Sleeve	19-5060	10	19-5061	6
3/8 O.D. x 1/4 O.D. Tube Integral Sleeve	19-5064	10	19-5065	6
1/2 O.D. x 3/8 O.D. Tube Integral Sleeve	19-5066	10	19-5067	6
5/8 O.D. x 3/8 O.D. Tube S.S. Gripper Sleeve	19-5068	10	19-5069	6
5/8 O.D. x 1/2 O.D. Tube S.S. Gripper Sleeve	19-5070	10	19-5071	6
7/8 O.D. x 5/8 O.D. Tube S.S. Gripper Sleeve	19-5072	10	19-5073	6
<b>MALE 90° ELL • Comp x MIP</b>				
1/4 O.D. Tube x 1/8 MIP Integral Sleeve	19-5082	10	19-5083	6
1/4 O.D. Tube x 1/4 MIP Integral Sleeve	19-5084	10	19-5085	6
1/4 O.D. Tube x 3/8 MIP Integral Sleeve	19-5086	10	19-5087	6
3/8 O.D. Tube x 1/4 MIP Integral Sleeve	19-5092	10	19-5093	6
3/8 O.D. Tube x 3/8 MIP Integral Sleeve	19-5094	10	19-5095	6
1/2 O.D. Tube x 1/4 MIP S.S. Gripper Sleeve	19-5096	10	19-5097	6
1/2 O.D. Tube x 3/8 MIP S.S. Gripper Sleeve	19-5098	10	19-5099	6
1/2 O.D. Tube x 1/2 MIP S.S. Gripper Sleeve	19-5100	10	19-5101	6
5/8 O.D. Tube x 1/2 MIP S.S. Gripper Sleeve	19-5102	10	19-5103	6
<b>UNION ELBOWS • Comp x Comp</b>				
1/4 O.D. Tube Integral Sleeve	19-5104	10	19-5105	6
3/8 O.D. Tube Integral Sleeve	19-5110	10	19-5111	6
1/2 O.D. Tube S.S. Gripper Sleeve	19-5112	10	19-5113	6
5/8 O.D. Tube S.S. Gripper Sleeve	19-5114	10	19-5115	6
7/8 O.D. Tube S.S. Gripper Sleeve	19-5116	10	19-5117	6
<b>UNION TEES • Comp</b>				
1/4 O.D. Tube Integral Sleeve	19-5124	10	19-5125	6
3/8 O.D. Tube Integral Sleeve	19-5130	10	19-5131	6
1/2 O.D. Tube S.S. Gripper Sleeve	19-5132	10	19-5133	6
5/8 O.D. Tube S.S. Gripper Sleeve	19-5134	10	19-5135	6
7/8 O.D. Tube S.S. Gripper Sleeve	19-5136	10	19-5137	6
7/8 x 7/8 x 5/8 O.D. Tube S.S. Gripper Sleeve	19-5138	10	19-5139	6
<b>MALE TEES • Comp x MIP</b>				
1/4 O.D. Tube x 1/8 MIP Integral Sleeve	19-5140	10	19-5141	6
1/4 O.D. Tube x 1/4 MIP Integral Sleeve	19-5142	10	19-5143	6
3/8 O.D. Tube x 1/4 MIP Integral Sleeve	19-5146	10	19-5147	6
3/8 O.D. Tube x 3/8 MIP Integral Sleeve	19-5148	10	19-5149	6
1/2 O.D. Tube x 3/8 MIP S.S. Gripper Sleeve	19-5150	10	19-5151	6
1/2 O.D. Tube x 1/2 MIP S.S. Gripper Sleeve	19-5152	10	19-5153	6
5/8 O.D. Tube x 1/2 MIP S.S. Gripper Sleeve	19-5154	10	19-5155	6

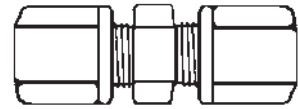

19-5040  
thru  
19-5067

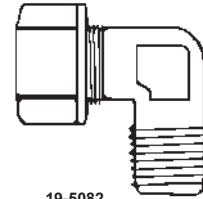

19-5082  
thru  
19-5095

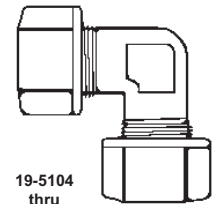

19-5104  
thru  
19-5111

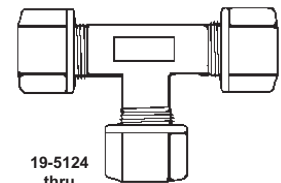

19-5124  
thru  
19-5131

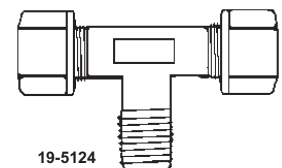

19-5124  
thru  
19-5131



# JACO NYLON VIBRA-PRUF® FITTINGS

ALL FITTINGS COME WITH STANDARD 1 PIECE INTEGRAL SLEEVE NUT

DESCRIPTION	BULK	QTY	CARDED	QTY
-------------	------	-----	--------	-----

## MALE RUN TEES • Comp x MIP

1/4 O.D. Tube x 1/8 MIP Integral Sleeve	19-5160	10	19-5161	6
1/4 O.D. Tube x 1/4 MIP Integral Sleeve	19-5162	10	19-5163	6

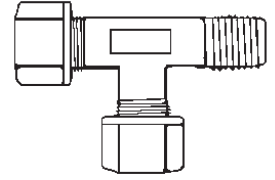

19-5160  
thru  
19-5163

## FEMALE ADAPTER • Comp x FIP

5/8 O.D. x 1/2 FIP S.S. Gripper Sleeve	19-5080	10	19-5081	6
--	---------	----	---------	---

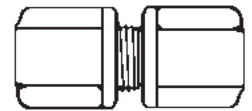

19-5080  
19-5081

## NUT WITH INTEGRAL SLEEVE

1/4 O.D. Tube Nut	19-5202	10	19-5203	6
3/8 O.D. Tube Nut	19-5206	10	19-5207	6
1/2 O.D. Tube Nut	19-5208	10	19-5209	6



19-5202  
thru  
19-5217

## NUT WITH PLASTIC GRIPPER (USED FOR HI PRESSURE 220 PSI SITUATIONS)

19-5212	BULK	1/4 Plastic Grip Nut	10
19-5213	CARDED	1/4 Plastic Grip Nut	6
19-5216	BULK	3/8 Plastic Grip Nut	10
19-5217	CARDED	3/8 Plastic Grip Nut	6

## VALVES

ITEM	PACKAGE	DESCRIPTION	PACK
------	---------	-------------	------

### VALVES STRAIGHT TUBE x FIP

19-5510	BULK	1/4 x 1/4	10
19-5511	CARDED	1/4 x 1/4	6
19-5512	BULK	3/8 x 1/4	10
19-5513	CARDED	3/8 x 1/4	6

19-5510  
thru  
19-5513

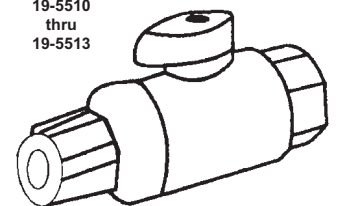

### VALVES ANGLE TUBE x FIP

19-5520	BULK	1/4 x 1/4	10
19-5521	CARDED	1/4 x 1/4	6
19-5522	BULK	3/8 x 1/4	10
19-5523	CARDED	3/8 x 1/4	6

19-5520  
thru  
19-5523

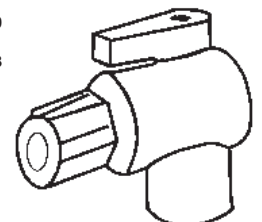

# JOHN GUEST PUSH-IN FITTINGS

GREY ACETAL COPOLYMER • GOOD FOR PRESSURE (AIR) UP TO 150 PSI  
USE ON POLYETHYLENE, BRAIDED, OR SOFT COPPER TUBING

## HOW TO MAKE A CONNECTION

To make a connection, the tube is simply pushed in by hand; the unique patented JOHN GUEST collet locking system then holds the tube firmly in place without deforming or restricting the flow.

### 1 Cut tube square



Cut tube square. It is essential that the outside diameter be free of score marks and that the burrs and sharp edges be removed before inserting into fitting.

### 2 Insert tube

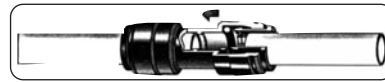

Fitting grips before it seals. Ensure tube is pushed into the tube stop.

### 3 Push up to tube stop

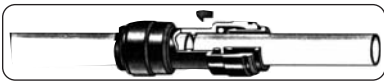

Push the tube into the fitting, to the tube stop. The collet (gripper) has stainless steel teeth which holds the tube firmly in position while the "O" ring provides a permanent leak proof seal.

### 4 Pull to check secure

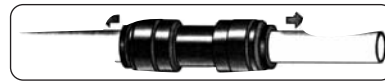

Pull on the tube to check that it is secure. It is good practice to test the system prior to leaving the site and / or before use.

## DISCONNECTING

Push in collet and remove tube

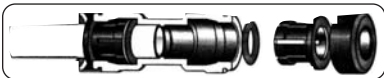

To disconnect, insure the system is depressurized before removing fitting. Push in collet squarely against the face of the fitting. With the collet held in this position, the tube can be removed. The fitting can then be reused.

## FITTINGS

ITEM	PACK	DESCRIPTION	CTN. QTY
<b>MALE ADAPTERS</b>			
19-6002	BULK	1/4 Tube x 1/8 Pipe	10
19-6003	CARDED		6
19-6004	BULK	1/4 Tube x 1/4 Pipe	10
19-6005	CARDED		6
19-6006	BULK	1/4 Tube x 3/8 Pipe	10
19-6007	CARDED		6
19-6012	BULK	3/8 Tube x 1/8 Pipe	10
19-6013	CARDED		6
19-6014	BULK	3/8 Tube x 1/4 Pipe	10
19-6015	CARDED		6
19-6016	BULK	3/8 Tube x 3/8 Pipe	10
19-6017	CARDED		6

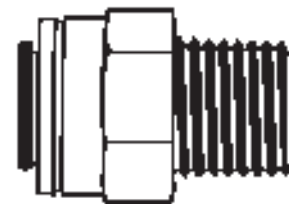

19-6002  
thru  
19-6017





# JOHN GUEST PUSH-IN FITTINGS

GREY ACETAL COPOLYMER • GOOD FOR PRESSURE (AIR) UP TO 150 PSI  
USE ON POLYETHYLENE, BRAIDED, OR SOFT COPPER TUBING

## FITTINGS

ITEM	PACK	DESCRIPTION	CTN. QTY
<b>MALE ADAPTERS</b>			
19-6082	BULK	1/4 Comp x 1/8 MIP 90° Ell	10
19-6083	CARDED		6
19-6084	BULK	1/4 Comp x 1/4 MIP 90° Ell	10
19-6085	CARDED		6
19-6086	BULK	1/4 Comp x 3/8 MIP 90° Ell	10
19-6087	CARDED		6
19-6092	BULK	3/8 Comp x 1/4 MIP 90° Ell	10
19-6093	CARDED		6
<b>COUPLING T x T</b>			
19-6040	BULK	1/4	10
19-6041	CARDED		6
19-6044	BULK	3/8	10
19-6045	CARDED		6
19-6064	BULK	3/8 x 1/4 Reducing	10
19-6065	CARDED		6
<b>ELBOW</b>			
19-6104	BULK	1/4	10
19-6105	CARDED		6
19-6110	BULK	3/8	10
19-6111	CARDED		6
19-6114	BULK	3/8 x 1/4 Reducing	10
19-6115	CARDED		6
<b>TEE</b>			
19-6124	BULK	1/4	10
19-6125	CARDED		6
19-6130	BULK	3/8	10
19-6131	CARDED		6
19-6134	BULK	3/8 x 1/4 x 3/8 Reducing	10
19-6135	CARDED		6
<b>STEM ADAPTER</b>			
19-6150	BULK	1/4 Stem x 1/8 MIP	10
19-6151	CARDED		6
19-6152	BULK	1/4 Stem x 1/4 MIP	10
19-6153	CARDED		6
19-6154	BULK	3/8 Stem x 1/4 MIP	10
19-6155	CARDED		6
19-6156	BULK	3/8 Stem x 3/8 MIP	10
19-6157	CARDED		6

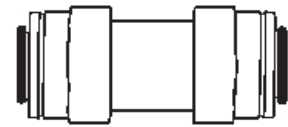
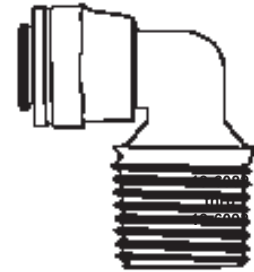

19-6040  
thru  
19-6065

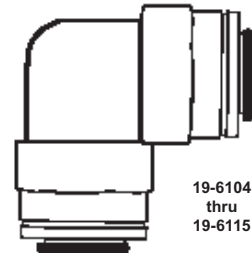

19-6104  
thru  
19-6115

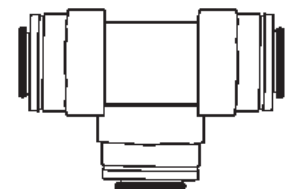

19-6124  
thru  
19-6135

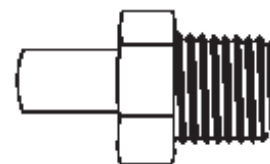

19-6150  
thru  
19-6157



# JOHN GUEST PUSH-IN FITTINGS

GREY ACETAL COPOLYMER • GOOD FOR PRESSURE (AIR) UP TO 150 PSI  
USE ON POLYETHYLENE, BRAIDED, OR SOFT COPPER TUBING

## FITTINGS

ITEM	PACK	DESCRIPTION	CTN. QTY
<b>FEMALE ADAPTERS</b>			
19-6172	BULK	1/4 Tube x 1/4 FIP	10
19-6173	CARDED		6
19-6174	BULK	3/4 Tube x 1/4 FIP	10
19-6175	CARDED		6
<b>FAUCET CONNECTORS</b>			
19-6180	BULK	1/4 X 7/16-24	10
19-6181	CARDED		6
19-6182	BULK	3/8 X 7/16-24	10
19-6183	CARDED		6
<b>LOCKING CLIP</b>			
19-6200	BULK	1/4	10
19-6201	CARDED		6
19-6202	BULK	3/8	10
19-6203	CARDED		6
<b>END CAP</b>			
19-6210	BULK	1/4	10
19-6211	CARDED		6
19-6212	BULK	3/8	10
19-6213	CARDED		6

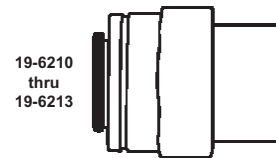
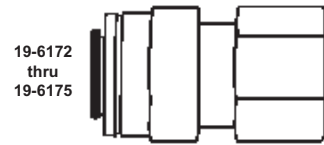

## VALVES

ITEM	PACK	DESCRIPTION	CTN. QTY
<b>STRAIGHT TUBE x TUBE</b>			
19-6500	BULK	1/4	10
19-6501	CARDED		6
19-6502	BULK	3/8	10
19-6503	CARDED		6
<b>STRAIGHT TUBE x FIP</b>			
19-6510	BULK	1/4	10
19-6511	CARDED		6
19-6512	BULK	3/8	10
19-6513	CARDED		6
<b>ANGLE TUBE x FIP</b>			
19-6520	BULK	1/4 x 1/4	10
19-6521	CARDED		6
19-6522	BULK	3/8 x 3/8	10
19-6523	CARDED		6

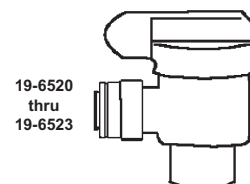
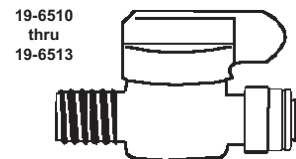
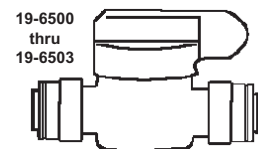

# Aqua-Pure<sup>®</sup>

**WATER FILTERS**

**ITEM            OEM NO.            DESCRIPTION**

*ALL CARTRIDGES ARE PACKED BY THE PAIR*

37-1034    AP-11T     Whole House • Dirt / Rust Water Filter • See Through Housing With Built-in Pressure Relief • 10 Year Warranty • 3/4 NPT • 6 GPM • Cold Water

37-1038    AP-101S    Whole House • Dirt / Rust Water Filter • Solid Housing With Built-in Shut-off Valve • 3/4 NPT • 6 GPM • Cold Water

37-1070    AP-110    Standard Replacement Cartridge For AP-11T & AP-101S • 5 Micron • Dirt / Rust • 1 Pair

37-1072    AP-124    Heavy Duty Replacement Cartridge For AP-11T & AP-101S • 50 Micron • Dirt / Rust • 1 Pair



37-1034



37-1038



37-1070  
37-1072

37-1036    AP-51T     Point of Use • Dirt / Rust • Taste / Odor Water Filter • See Through Housing With Built-in Pressure Relief • 10 Year Limited Warranty • 3/4 NPT • 3 GPM • Cold Water

37-1076    AP-117    Replacement Cartridge For AP-51T • Dual Action • 5 Micron • Dirt / Rust • Activated Carbon

37-1080    AP-S-117    Replacement Cartridge For AP-51T Triple Action • Dirt / Rust • Taste / Odor • Scale



37-1036



37-1076  
37-1080

37-1200    AP-500     Point of Use • Triple Action Filter 10 Year Warranty • Dirt / Rust • Taste / Odor • Scale • 3/8" NPT • 2 GPM • Cold Water

37-1202    AP-517    Replacement Cartridge For AP-500 Triple Action • Dirt / Rust • Taste / Odor • Scale



37-1044



37-1200

37-1044    AP-200     Under-Sink Water Filter 10 Year Warranty • Dual Action • Dirt / Rust • Taste / Odor • 3/8 NPT • 1 GPM • Compact Design

37-1046    AP-217    Replacement Cartridge For AP-200 Dual Action • Dirt / Rust • Taste / Odor



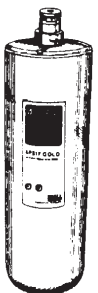

37-1046



37-1202



# AQUA PURE WATER FILTERS

ITEM	OEM NO.	DESCRIPTION
37-1048	AP-300	 Point Of Use Water Filter • Triple Action • Dirt / Rust • Taste / Odor • Scale • Built in shut-off • With Mounting Bracket • ¼ NPT • ½ GPM
37-1050	AP-317	Replacement Cartridge For AP-300 Triple Action • Dirt / Rust • Taste / Odor • Scale
37-1052	AP-400	Hot Water Heater Filter • Dual Action • Dirt / Rust • Scale • ¾ FPT • 6 GPM • Cold Water Feed • Stainless Steel Housing With Brass Head
37-1054	AP-410	Replacement Cartridge For AP-400 Dual Action • Dirt / Rust • Scale
37-1040	AP-1610	 Heavy Duty Whole House Filter • Stainless Steel Housing With Brass Head Rated To 300 PSI • 10 Year Warranty • Dirt / Rust • ¾ FPT • 6 GPM • Hot Or Cold Water
37-1070	AP-110	Standard Replacement Cartridge For AP-1610 5 Micron • Dirt / Rust
37-1072	AP-124	Heavy Duty Replacement Cartridge For AP-1610 50 Micron • Dirt / Rust
37-1076	AP-117	Replacement Cartridge For AP-1610 Dual Action • Dirt / Rust • Taste / Odor
37-1080	AP-S-117	Replacement Cartridge For AP-1610 Triple Action • Dirt / Rust • Taste / Odor • Scale
37-1078	AP-420	Replacement Cartridge For AP-1610 Dual Action • Dirt / Rust • Scale
37-1056	AP-450	Scale Stopper Filter With Bracket ¼ FPT • ½ GPM • Cold Water
37-1058	AP-460	Replacement Cartridge For AP-450
<b>REPLACEMENT PARTS</b>		
37-1060	AP-35076-75C	Gasket For AP-200
37-1062	AP-63562-01	Gasket For AP-400 & AP-1610
37-1092	AP-36851-34C	Gasket For AP10
37-1096	AP-34245-31C	Seal Plate For AP-10

